

CDD36

Diode-Diode Modules

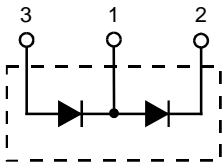
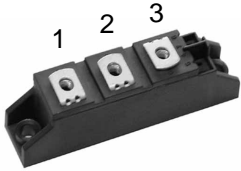

Type	V_{RSM} V	V_{RRM} V
CDD36N08	900	800
CDD36N12	1300	1200
CDD36N14	1500	1400
CDD36N16	1700	1600
CDD36N18	1900	1800

Dimensions in mm (1mm=0.0394")

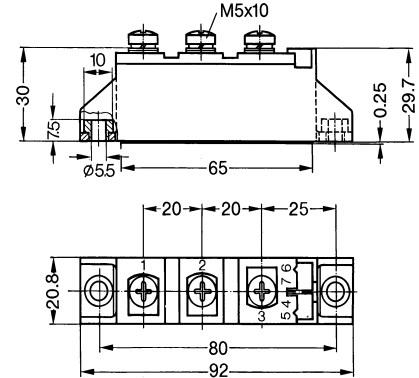

Symbol	Test Conditions	Maximum Ratings	Unit
I_{FRMS} I_{FAVM}	$T_{VJ}=T_{VJM}$ $T_C=100^{\circ}C$; 180° sine	60 36	A
I_{FSM}	$T_{VJ}=45^{\circ}C$ $V_R=0$ t=10ms (50Hz), sine t=8.3ms (60Hz), sine	650 760	A
	$T_{VJ}=T_{VJM}$ $V_R=0$ t=10ms(50Hz), sine t=8.3ms(60Hz), sine	580 630	
$\int i^2 dt$	$T_{VJ}=45^{\circ}C$ $V_R=0$ t=10ms (50Hz), sine t=8.3ms (60Hz), sine	2100 2400	A^2s
	$T_{VJ}=T_{VJM}$ $V_R=0$ t=10ms(50Hz), sine t=8.3ms(60Hz), sine	1700 1900	
T_{VJ} T_{VJM} T_{stg}		-40...+150 150 -40...+125	$^{\circ}C$
V_{ISOL}	50/60Hz, RMS $I_{ISOL} \leq 1mA$ t=1min t=1s	3000 3600	V~
M_d	Mounting torque (M5) Terminal connection torque (M5)	2.5-4/22-35 2.5-4/22-35	Nm/lb.in.
Weight	Typical including screws	90	g

CDD36

Diode-Diode Modules

Symbol	Test Conditions	Characteristic Values	Unit
I_R	$T_{VJ}=T_{VJM}; V_R=V_{RRM}$	10	mA
V_F	$I_F=80A; T_{VJ}=25^{\circ}C$	1.38	V
V_{TO}	For power-loss calculations only	0.8	V
r_T	$T_{VJ}=T_{VJM}$	6.1	m Ω
Q_S	$T_{VJ}=125^{\circ}C; I_F=25A; -di/dt=0.6A/us$	50	μC
I_{RM}		6	A
R_{thJC}	per diode; DC current per module	1.0 0.5	K/W
R_{thJK}	per diode; DC current per module	1.2 0.6	K/W
d_s	Creepage distance on surface	12.7	mm
d_A	Strike distance through air	9.6	mm
a	Maximum allowable acceleration	50	m/s ²

FEATURES

- * International standard package
- * Direct copper bonded Al₂O₃-ceramic base plate
- * Planar passivated chips
- * Isolation voltage 3600 V~
- * UL registered, E 72873

APPLICATIONS

- * Supplies for DC power equipment
- * DC supply for PWM inverter
- * Field supply for DC motors
- * Battery DC power supplies

ADVANTAGES

- * Space and weight savings
- * Simple mounting
- * Improved temperature and power cycling
- * Reduced protection circuits

CDD36

Diode-Diode Modules

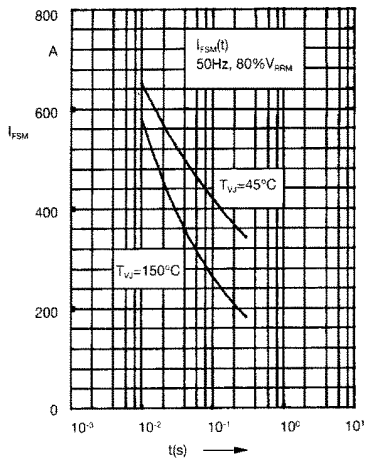

Fig. 1 Surge overload current
 I_{FSM} : Crest value, t : duration

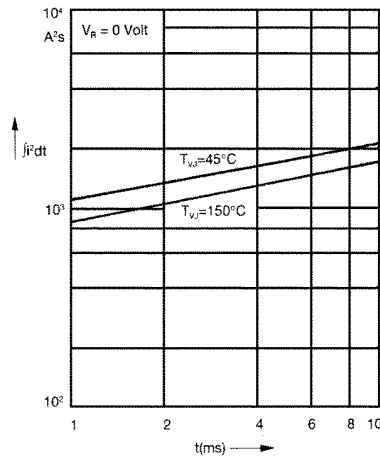

Fig. 2 $\int i^2 dt$ versus time (1-10 ms)

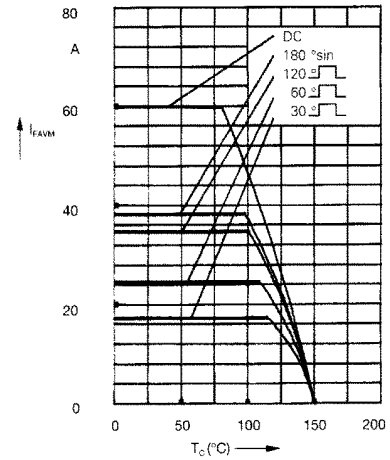

Fig. 2a Maximum forward current at case temperature

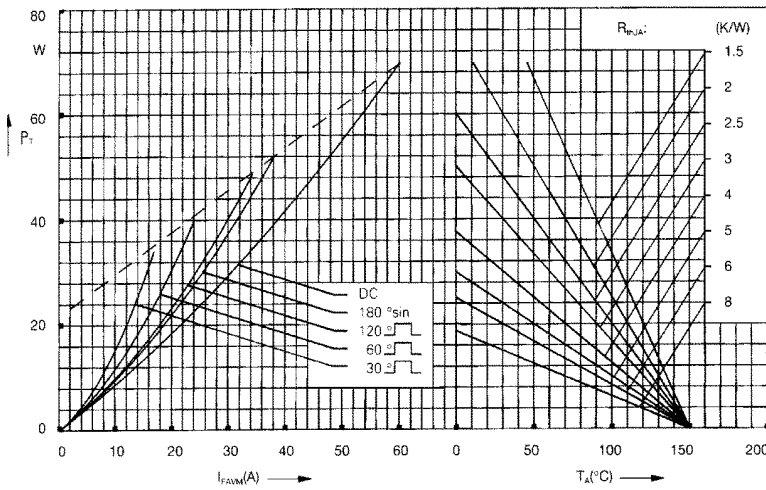

Fig. 3 Power dissipation versus forward current and ambient temperature (per diode)

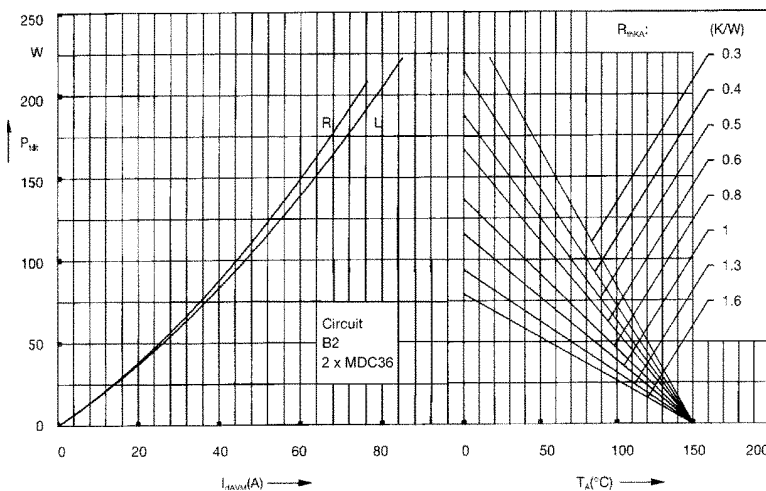

Fig. 4 Single phase rectifier bridge:
Power dissipation versus direct output current and ambient temperature
R = resistive load
L = inductive load

CDD36

Diode-Diode Modules

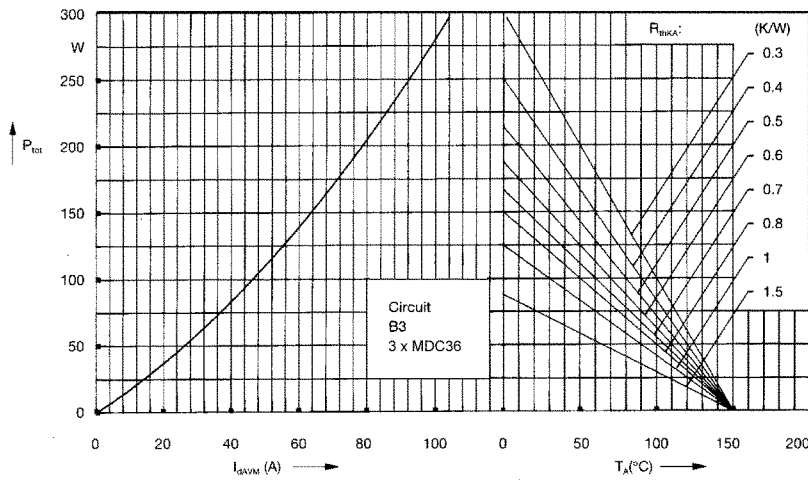

Fig. 5 Three phase rectifier bridge: Power dissipation versus direct output current and ambient temperature

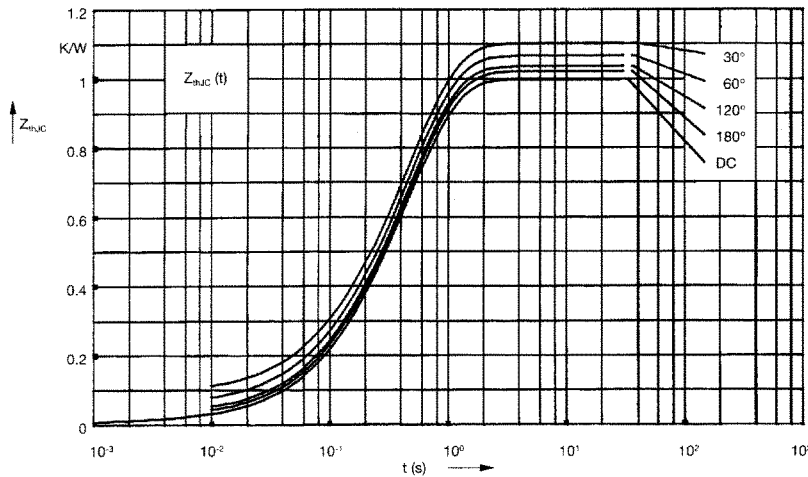

Fig. 6 Transient thermal impedance junction to case (per diode)

R_{thJC} for various conduction angles d:

d	R_{thJC} (K/W)
DC	1.00
180°C	1.02
120°C	1.04
60°C	1.07
30°C	1.10

Constants for Z_{thJC} calculation:

i	R_{thi} (K/W)	t_i (s)
1	0.01	0.0012
2	0.03	0.095
3	0.96	0.455

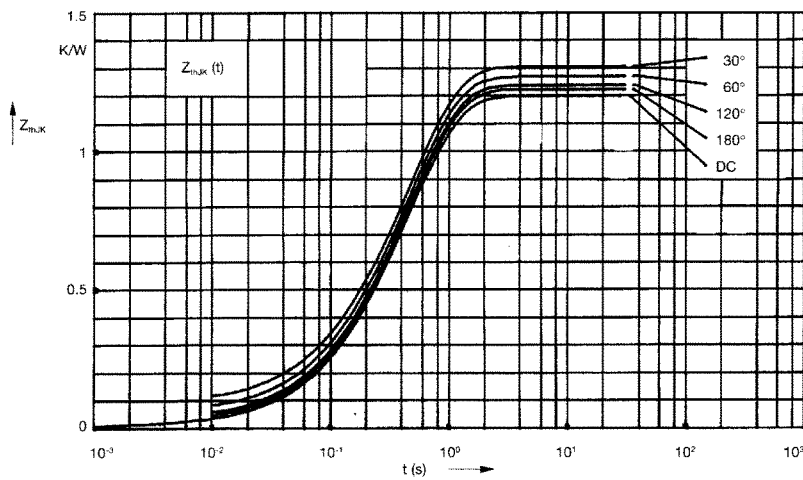

Fig. 7 Transient thermal impedance junction to heatsink (per diode)

R_{thJK} for various conduction angles d:

d	R_{thJK} (K/W)
DC	1.20
180°C	1.22
120°C	1.24
60°C	1.27
30°C	1.30

Constants for Z_{thJK} calculation:

i	R_{thi} (K/W)	t_i (s)
1	0.01	0.0012
2	0.03	0.095
3	0.96	0.455
4	0.2	0.495