

CDD165

Diode-Diode Modules

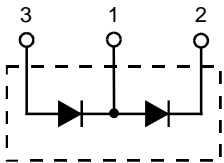
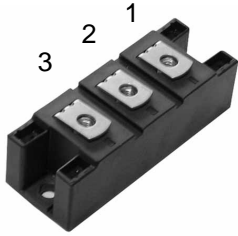

Type	V_{RSM} V	V_{RRM} V
CDD165N08	900	800
CDD165N12	1300	1200
CDD165N14	1500	1400
CDD165N16	1700	1600
CDD165N18	1900	1800

Dimensions in mm (1mm=0.0394")

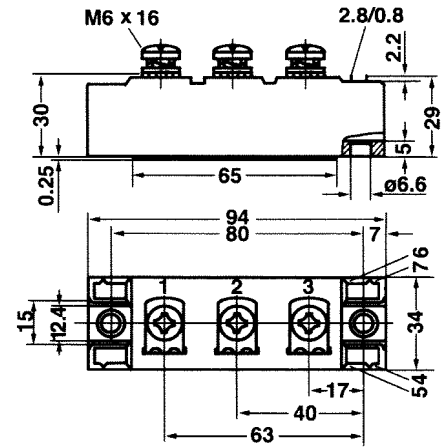

Symbol	Test Conditions	Maximum Ratings	Unit
I_{FRMS} I_{FAVM}	$T_{VJ}=T_{VJM}$ $T_C=100^{\circ}C$; 180° sine	300 165	A
I_{FSM}	$T_{VJ}=45^{\circ}C$ $V_R=0$ t=10ms (50Hz), sine t=8.3ms (60Hz), sine	4700 5000	A
	$T_{VJ}=T_{VJM}$ $V_R=0$ t=10ms(50Hz), sine t=8.3ms(60Hz), sine	4100 4300	
$\int i^2 dt$	$T_{VJ}=45^{\circ}C$ $V_R=0$ t=10ms (50Hz), sine t=8.3ms (60Hz), sine	110000 104000	A^2s
	$T_{VJ}=T_{VJM}$ $V_R=0$ t=10ms(50Hz), sine t=8.3ms(60Hz), sine	84000 77000	
T_{VJ} T_{VJM} T_{stg}		-40...+150 150 -40...+125	$^{\circ}C$
V_{ISOL}	50/60Hz, RMS $I_{ISOL} \leq 1mA$ t=1min t=1s	3000 3600	V~
M_d	Mounting torque (M6) Terminal connection torque (M6)	2.25-2.75/20-25 4.5-5.5/40-48	Nm/lb.in.
Weight	Typical including screws	120	g

CDD165

Diode-Diode Modules

Symbol	Test Conditions	Characteristic Values	Unit
I_R	$T_{VJ}=T_{VJM}; V_R=V_{RRM}$	20	mA
V_F	$I_F=300A; T_{VJ}=25^{\circ}C$	1.3	V
V_{TO}	For power-loss calculations only	0.8	V
r_T	$T_{VJ}=T_{VJM}$	1.3	m Ω
Q_S	$T_{VJ}=125^{\circ}C; I_F=300A; -di/dt=50A/us$	550	μC
I_{RM}		235	A
R_{thJC}	per diode; DC current per module	0.21 0.105	K/W
R_{thJK}	per diode; DC current per module	0.31 0.155	K/W
ds	Creepage distance on surface	12.7	mm
dA	Strike distance through air	9.6	mm
a	Maximum allowable acceleration	50	m/s ²

FEATURES

- * International standard package
- * Direct copper bonded Al₂O₃-ceramic base plate
- * Planar passivated chips
- * Isolation voltage 3600 V~
- * UL registered, E 72873

APPLICATIONS

- * Supplies for DC power equipment
- * DC supply for PWM inverter
- * Field supply for DC motors
- * Battery DC power supplies

ADVANTAGES

- * Space and weight savings
- * Simple mounting
- * Improved temperature and power cycling
- * Reduced protection circuits

CDD165

Diode-Diode Modules

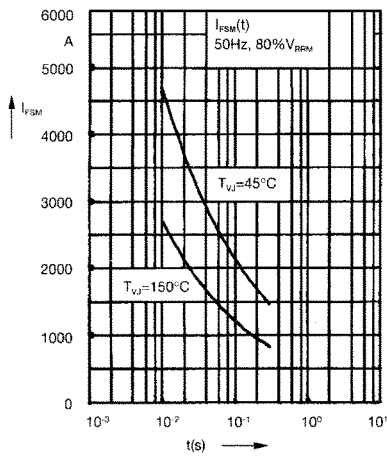

Fig. 1 Surge overload current
 I_{FSM} : Crest value, t : duration

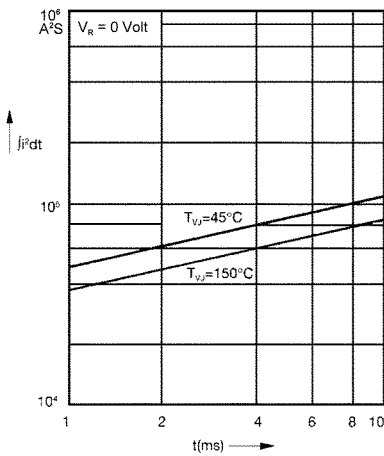

Fig. 2 $\int j^2 dt$ versus time (1-10 ms)

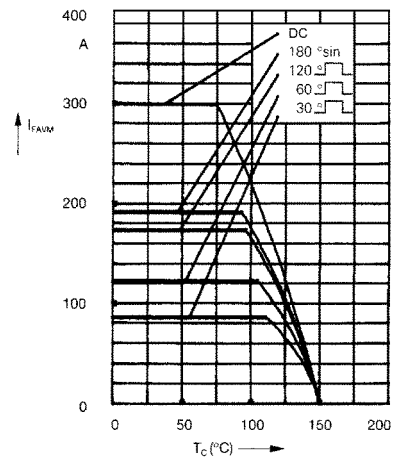

Fig. 2a Maximum forward current at case temperature

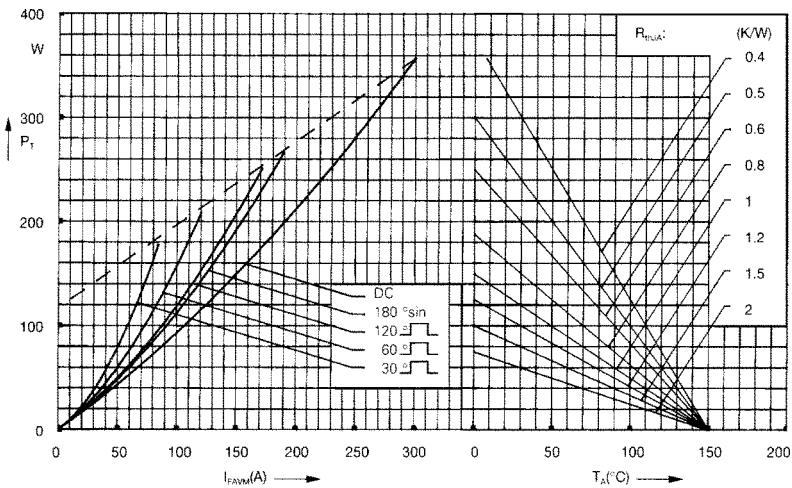

Fig. 3 Power dissipation versus forward current and ambient temperature (per diode)

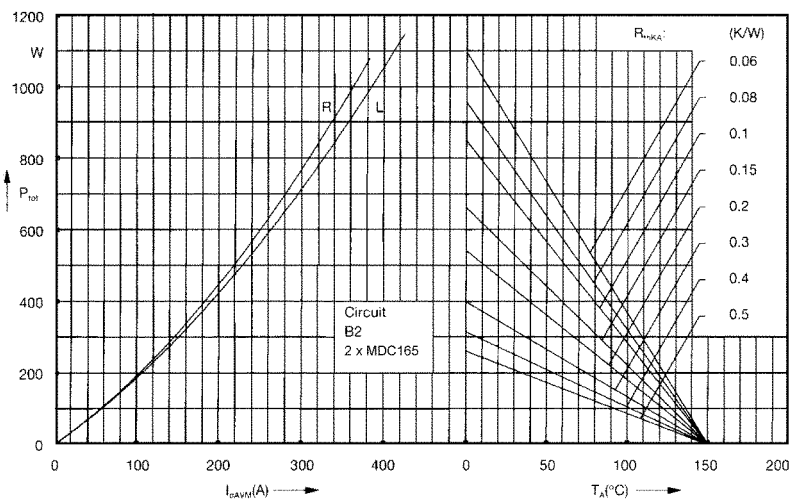

Fig. 4 Single phase rectifier bridge:
Power dissipation versus direct output current and ambient temperature
R = resistive load
L = inductive load

CDD165

Diode-Diode Modules

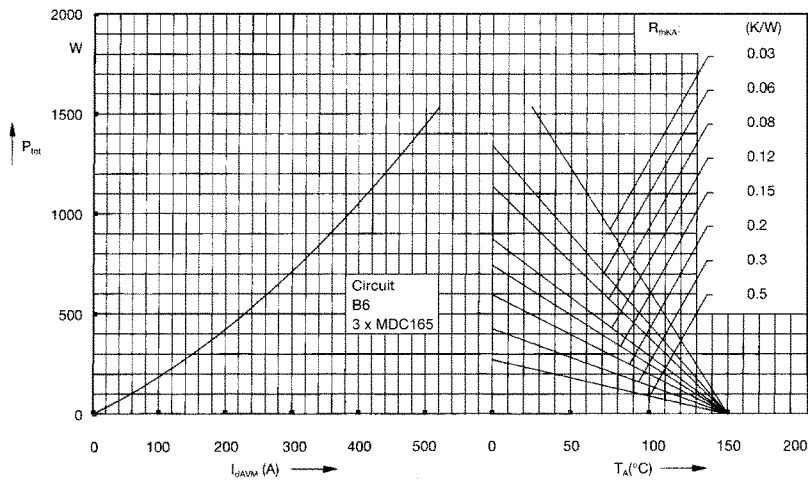

Fig. 5 Three phase rectifier bridge: Power dissipation versus direct output current and ambient temperature

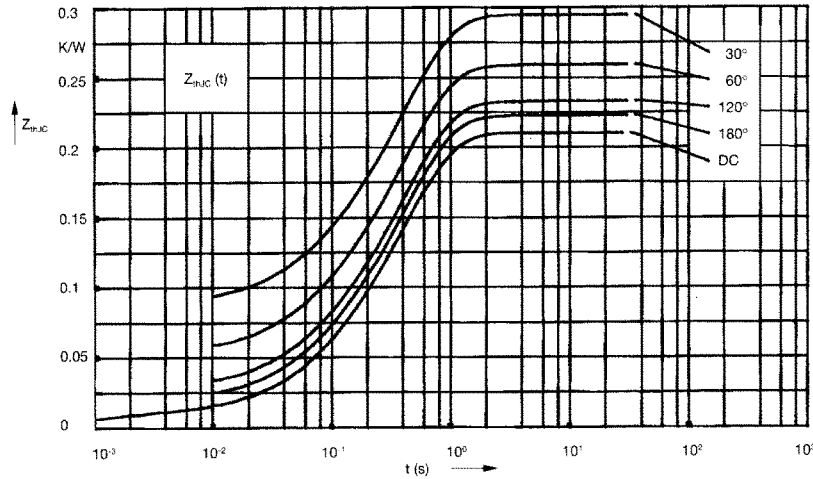

Fig. 6 Transient thermal impedance junction to case (per diode)

$R_{\theta JC}$ for various conduction angles d :

d	$R_{\theta JC}$ (K/W)
DC	0.210
180°C	0.223
120°C	0.233
60°C	0.260
30°C	0.295

Constants for $Z_{\theta JC}$ calculation:

i	$R_{\theta i}$ (K/W)	t_i (s)
1	0.0087	0.001
2	0.0163	0.065
3	0.185	0.4

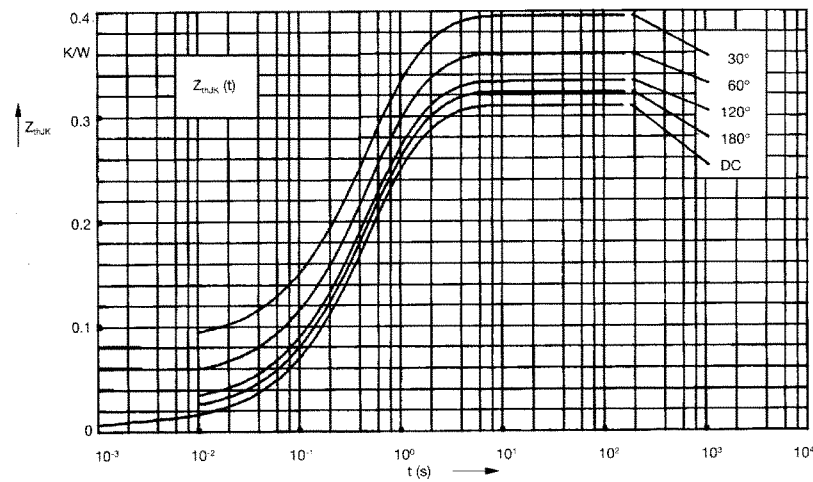

Fig. 7 Transient thermal impedance junction to heatsink (per diode)

$R_{\theta JK}$ for various conduction angles d :

d	$R_{\theta JK}$ (K/W)
DC	0.31
180°C	0.323
120°C	0.333
60°C	0.360
30°C	0.395

Constants for $Z_{\theta JK}$ calculation:

i	$R_{\theta i}$ (K/W)	t_i (s)
1	0.0087	0.001
2	0.0163	0.065
3	0.185	0.4
4	0.1	1.29